



AFX Series

High Frequency AC/DC Power Source 6kW up to 180kW

High Efficiency, High Frequency, Advanced Programmability



Key Specifications

- Single, Split, Three-Phase
- 85% Energy Efficiency
- up to 15kVA in 4 U chassis
- 6kW parallelable up to 180kW
- Voltage Range: 300Vac L-N/520Vac L-L or ± 425 Vdc; Extended: 333V L-N
- Frequency: 15 - 1200Hz;
(Extended Mode 1Hz to 3000Hz)

Highlights

- Modular and Scalable Power
- Constant Power and Seamless Switching between AC and DC
- Multi-Channel Testing Capability with Unique 6 Form Configuration
- Phase Angle Programming
- Programmable Impedance
- Active Three Phase PFC input with Inrush Current Limiting
- Precise Voltage & Load Regulation
- Metering of Volts, RMS Current, Peak Current, Apparent & True Power
- Harmonics (Interharmonics option)
- Advanced Scope Function
- Sine, Square, Triangle, Clipped Sine & Arbitrary Waveforms
- Transients Prog. (LIST, PULSE, STEP)
- Full Galvanic Isolation
- **SmartSource Suite** Control Platform

AFX Series Overview

Discover one of our top sellers for high-frequency power sources. Scale power from 6kW up to 180kW with AC, DC, AC +DC, DC+AC multi-channel configurations. The AFX Series is 85% energy efficient, dynamic, and cost-effective. Its wide operating envelope, and extended voltage and frequency range options provide great flexibility for testing in R&D and production. Its proven reliability and our long-term support makes the AFX an easy choice for aerospace and defense programs.

Application Examples:

- Aerospace & Defense
- Data Center Networks & Servers
- Industrial, Semi-Conductor, Power Supplies
- Medical, White Goods, Appliances, HVAC
- Unidirectional AC/DC Applications

Key Advantages



85% Energy Efficiency
& Unique Sleep Mode



High Frequency Converter,
Proven Long-Term Reliability



Advanced Transients &
Programming Capability



AC, DC, AC+DC, DC+AC
Ultra Flexible 6 Form Configuration



Modular & Scalable Power up to 180kW

- Flexibility to scale power now or later as you need it
- Paralleled units can have different power ratings
- Auxiliary no-controller models offer low-cost option
- Complete integrated 19" Rack systems; select from 18U, 32U, and 42U standard cabinet sizes
- Parallel configuration kits available for system integrators using their own cabinets.



Constant Power Provides Wide Operating Envelope

Unlike traditional AC power sources, which trade off voltage and current, the AFX Series operates along a constant power curve providing an extended operating range.

In DC mode, the AFX Series maintains a constant power 425VDC range, delivering both high voltage and current without the need for switching.

- More current at lower voltages and higher voltage at lower currents
- A wider operating range without switching voltage ranges
- Uninterrupted output, preventing EUT shutdown during testing

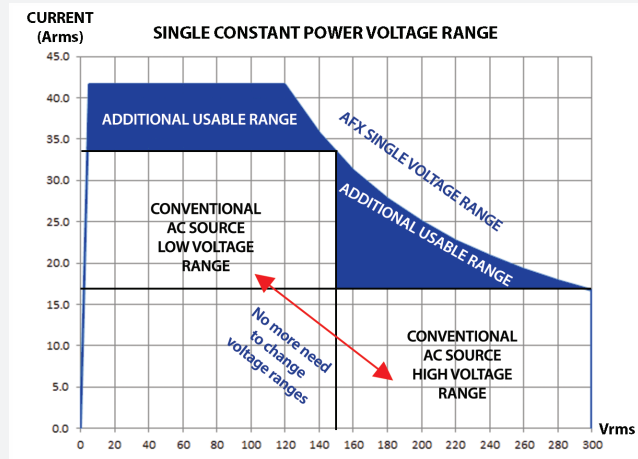

3150AFX (15kVA) operating at a constant 5 kVA per phase. The blue-shaded area shows expanded range compared to conventional 150V/300V sources.

Extended Voltage Range Operation to 333Vac LN

The extended range increases max. output voltage to 333Vac L-N / 576Vac L-L from 45Hz to 800Hz

- Supports over-voltage testing up to 20% above 480V nominal equipment.
- Tests single-phase universal 90V–265V AC input products up to 120% of their max. nominal input.

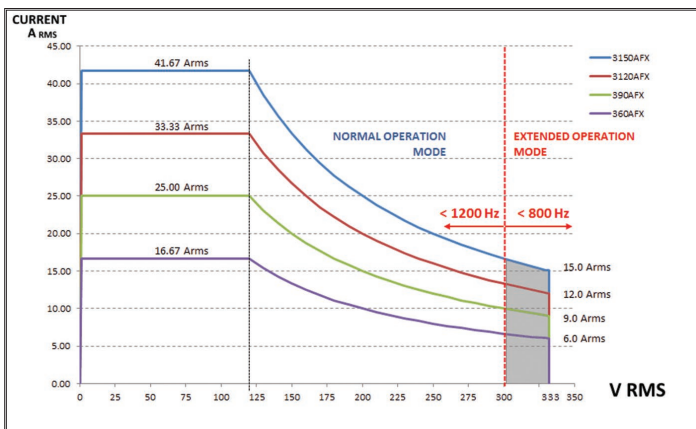

Three Phase Mode Extended Voltage Range Constant Power

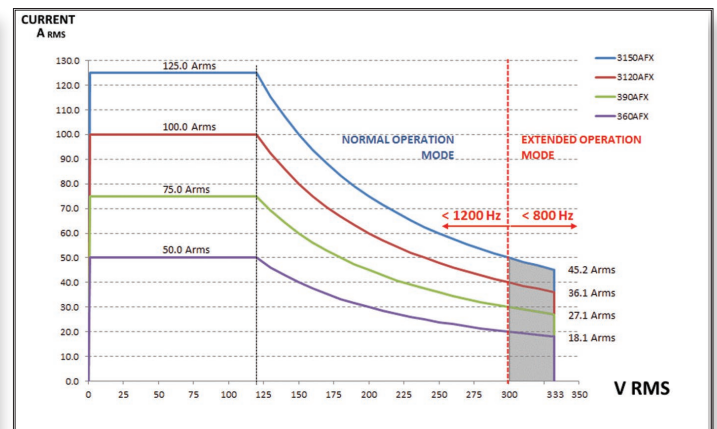

Single Phase Mode Extended Voltage Range Constant Power

Ultimate Flexibility With Six Output Configurations

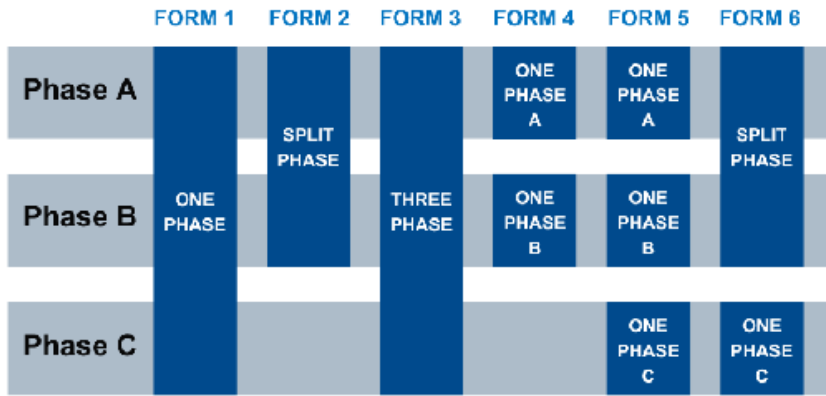

Test various conditions and EUTs with six output configurations. For example, a 15kW AFX can test three independent 5kW EUTs simultaneously in AC or DC.

- Forms 1–3 cover common AC setups
- Forms 4–6 enable testing multiple EUTs with one AFX unit.
- Form 5 supports different frequencies per phase.

Advanced Programming and Transients Capability

The AFX Series enables easy creation of voltage, waveform, and frequency transients and can be applied to individual or all three phases in AC, DC, and AC+DC modes. Find over 200 arbitrary waveforms available to customize as needed. Save time and increase productivity.

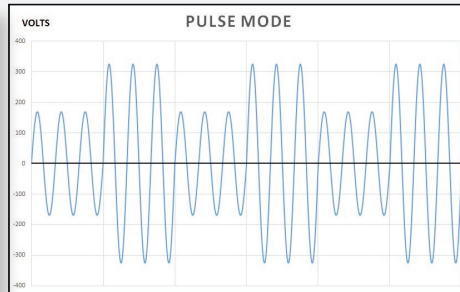
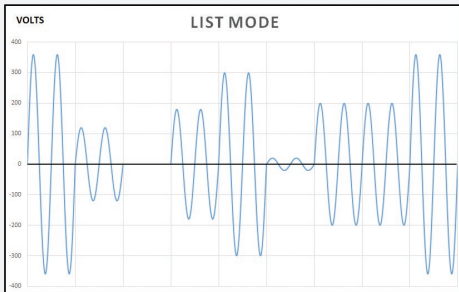

High Frequency & Extended Range up to 3000Hz

Extended mode operates from 1Hz to 3000Hz with some power or voltage derating. Voltage, current, and power profiles for 1200–3000Hz are shown in the graphs below. For 1–15Hz, only power output is derated.

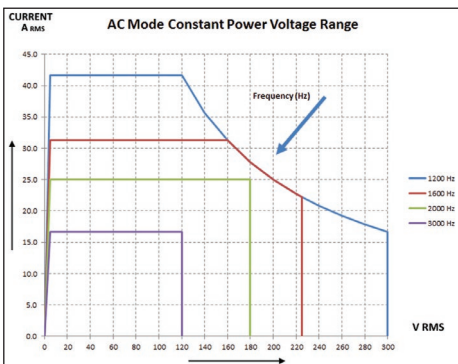

Three Phase Mode 1200~3000Hz

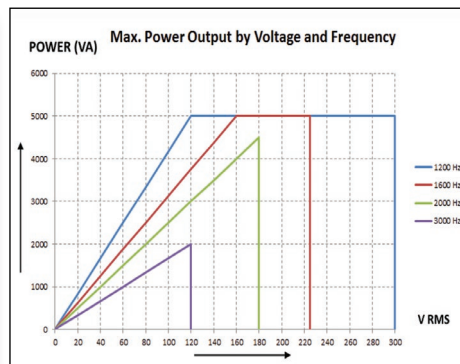

Three Phase Mode 1200~3000Hz

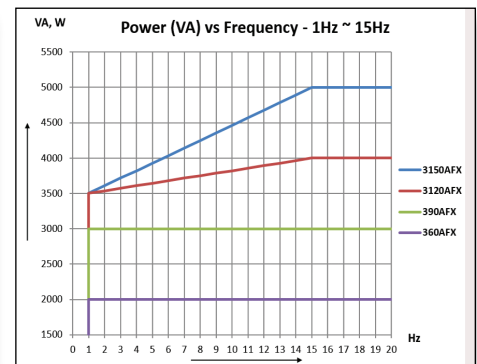

Three Phase Mode 1~15Hz

Simplify Test with Multiple Control Options

Easily access and control the unit through the front panel, USB, or via Ethernet (LAN) on any web browser.

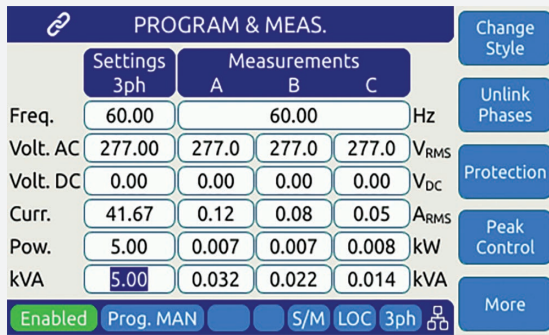
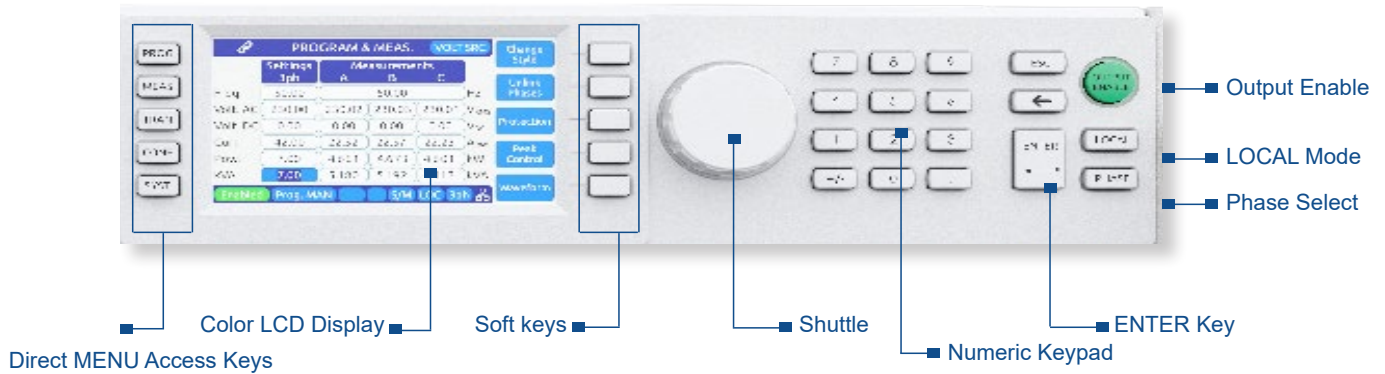

Program & Measurement Screen

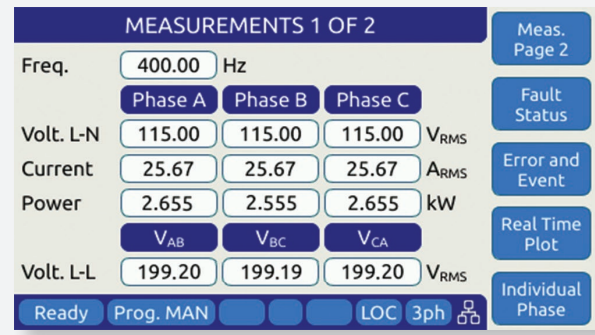

Measurement Screen

SmartSource Suite, Built-In

Breakthrough Remote Control Platform for Enhanced Visualization & Control

The **SmartSource Suite** is an embedded web server that allows you to fully access and control Pacific Power Source products on any web browser, in real-time with an enhanced user experience and visualization tools.

Its intuitive user-interface, full access to all test functions, and easy programming capabilities substantially reduce test time and increase productivity.

- Enhanced Visualization
- Intuitive Test Creation & Execution
- Pre-Written Test Sequences
- Usability Without Limits



Access SmartSource Suite on Any Web Browser in Real-Time

Series Mode Output Configuration (S Option - Specific Regions Only)

The “S” version of the AFX series enables two units to connect in series, doubling output voltage in AC and DC modes—up to 600Vac RMS (L-N), 1040Vac (L-L) in three-phase, and ± 850 VDC.

For applications needing high and low voltage, the SPMS option (up to 60kVA) allows switching between series and parallel modes via the front panel, web interface, or test program commands.

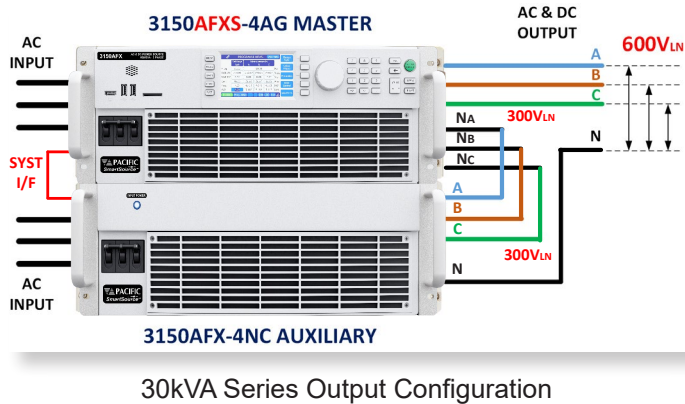

MODEL	POWER	V RANGE	19" CABINET
3120AFXS	12kVA / kW	0-600 Vac LN 0-1040 Vac LL 0- ± 850 Vdc	28U
3180AFXS	18kVA / kW		28U
3240AFXS	24kVA / kW		28U
3300AFXS	30kVA / kW		28U
3600AFXS	60kVA / kW		28U
3900AFXS	90kVA / kW		36U
SPMS	Automatic Series and Parallel Mode Configuration Switch. Max. power level is 60kVA.		
Note: SPMS switch is only available for 2 or 4 units. Other configurations are available on request.			

High Voltage Output Transformer (T Option)

For AC applications requiring over 333Vac LN, the external output transformer adds an AC-only mode with expanded voltage ranges based on phase mode.

Single Phase	Split Phase	Three Phase
0-400 VL-N	0-800 VL-L	0-400 VL-N/0-692 VL-L

Standard AC and DC voltage ranges remain available. For voltages higher than 400VL-N, contact factory.

Constant Power Mode

The 400V transformer range has a constant power profile. Full power is available down to 160 Vac L-N/277 Vac L-L on the 400V range. See V-I profiles chart.

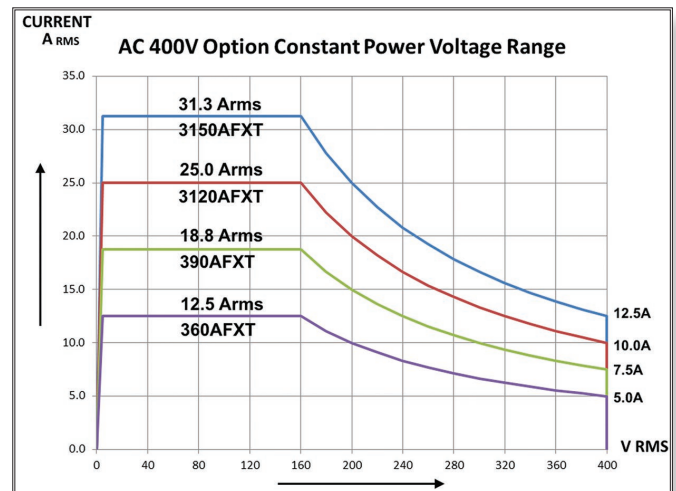

Three Phase Mode 400 V Range Constant Power Profile

ELECTRICAL	SPECIFICATIONS
Output Mode	AC Only. No DC or AC+DC modes on T Option range
Voltage Range	0-400 Vac LN / 0-692Vac LL
Resolution	0.01 V
Accuracy	$\pm (0.25\% + 0.25\% \cdot f \text{ (kHz)})$ F.S.
Voltage Sense	Auto scales for T option range
Frequency Range	45Hz - 1000Hz Derating: Voltage < 45Hz, Current > 1000Hz
Constant Power Mode	From 40% to 100% of V range

MECHANICAL	SPECIFICATIONS
Mechanical - T Option Chassis (15kVA rated)	
H x W x D	7.0" x 17.0" x 25.0" 178 x 482 x 635 mm
Weight	170 lbs. / 77.1 kg
Mechanical - Cabinet Systems	
Dimensions / Weight	Refer to AFX Cabinet Systems data sheet

Note 1: Extended frequency ranges are not supported on this optional AC coupled voltage range.

Technical Specifications

PARAMETERS / FUNCTIONS	SPECIFICATIONS			
OUTPUT VOLTAGE				
Modes	AC, DC, AC+DC, DC+AC			
Phase Modes	Single Phase (FORM1), Split Phase (FORM2), Three Phase (FORM3)			
Voltage Ranges	AC: 0 - 300 Vrms LN / 0 - 520 Vrms LL DC: 0 - 425 Vdc			
Extended Voltage Ranges	AC: 0 - 333 Vrms LN / 0 - 576 Vrms LL T Option: 400V or 600 Series Mode: 0 - 600V			
Programming Resolution & Accuracy	0.01 V $\pm 0.25\%$ Full Scale			
Waveforms (Max. = 200)	Sine, Square, Triangle, Clipped Sine (THD), Saw Tooth, Triangle, Arbitrary			
DC Offset	< 20 mV dc			
Harmonic Distortion (R load)	< 100 Hz < 0.3% 100 - 500 Hz < 0.5% 500 - 1000 Hz < 1.0% > 1000 Hz < 1.5%			
Switching Noise	< 150 mV RMS DC to 300 kHz			
Load Regulation	AC Mode: $\pm 0.02\%$ (CSC Mode ON)		DC Mode: $\pm 0.02\%$ (CSC Mode ON)	
Line Regulation	AC Mode: < 0.1% for 10% AC Line input change, < 0.02% with CSC Mode ON			
Voltage Sense - External	External or (Auto) Internal Sense Max. voltage drop 5% of Full Scale			
Output Isolation	550 Vac			
Voltage Slew Rate	Programmable AC > 1.0 V/msec DC > 3.0 V/msec			
OUTPUT FREQUENCY				
Frequency Ranges	Standard Range: DC, 15.00 Hz - 1200.0 Hz Extended Range ¹ 1.00 Hz - 3000.0 Hz			
Programming Resolution & Accuracy	0.01 Hz $\pm 0.01\%$			
Output Current				
Current Limit	RMS Mode & Peak Current Mode			
Range	RMS: See Model table page 9		Peak Current: 104 Apk/phs max per AFX unit	
Crest Factor	360AFX: 6.3:1 390AFX: 4.16:1 3120AFX: 3.12:1 3150AFX: 2.5:1			
Programming Resolution & Accuracy	0.01 Arms $\pm 0.5\%$ of Full Scale			
Current Protection Modes	Constant Current (CC) or Output Trip (CV)			
Current Overload Mode	Allows 130% of max. RMS current for up to 2.0 secs before CP is triggered when enabled			
OUTPUT PHASE ANGLES (FORM2 & FORM3)				
Phase Angle Range & Resolution	0.0° - 359.9° 0.1°			
PROGRAMMABLE IMPEDANCE (Per unit, including parallel units)				
Modes	Real-time mode, RMS mode			
Resistance (R)	1 Phase & 3 Phase:	$\pm 10 \Omega$	2 Phase:	$\pm 20 \Omega$
Inductance (L)	1 Phase & 3 Phase:	0 - 2 mH	2 Phase:	0 - 4 mH
PROTECTIONS				
Available Protection Settings	Over Current fold-back or trip Prog. Peak Current Limit Power fold-back or trip App. Power fold-back or trip Over Voltage trip Over Temperature trip			
Over Voltage Protection Range	0 ~ 105% of voltage range			
AC Input Voltage	Over Voltage & Under Voltage, $\pm 15\%$ from Nominal			

Footnotes:

1: Power restrictions apply below 15Hz and Voltage and Power restrictions apply above 1200Hz.

MEASUREMENTS	Range	Resolution	Accuracy	
AC Voltage (Vrms)	0–350VLN/0-600VLL ⁽²⁾	FP: 10 mV / Bus: 1 mV	± 0.25% F.S.	
AC Current (Arms)	See Table page 9	FP: 10 mA / Bus: 1 mA	± 0.5% F.S. ⁽³⁾	
Current Crest Factor	1.00 - 5.00	FP: 0.01 / Bus: 0.001	± 2.0% F.S. ⁽³⁾	
Power (kW)	See Table page 9	FP: 1 W / Bus: 0.1 W	± 1.5% F.S. ⁽⁴⁾	
Apparent Power (kVA)	See Table page 9	FP: 1 VA / Bus: 0.1 VA	± 1.5% F.S. ⁽⁴⁾	
Power Factor	0.00 - 1.00 ⁽⁴⁾	FP: 0.01 / Bus: 0.001	-	
DC Voltage (Vdc)	0 – 440 Vdc ⁽⁵⁾	FP: 10 mV / Bus: 1 mV	± 0.25% F.S.	
DC Current (Idc)	See Table page 9	FP: 10mA / Bus: 1mA	± 0.5% F.S. ⁽³⁾	
TRANSIENT FUNCTIONS				
Programming	200 Steps / 400 Segments, LIST, PULSE & STEP Modes, Frequency, Volt AC, Volt DC, Waveform, Ramp Time, Dwell Time. Time range: 0.1 - 10000000.0 ms, Time resolution 0.2			
Execution	Run from step # to step #, Run, Step, Restart, Stop			
Program Storage	Non-volatile, 100 Programs + Transients			
ANALOG I/O (DB25 Connector Rear Panel)				
Analog Inputs (4)	AI1, AI2, AI3, AI4 User defined functions			
Range, Accuracy, Impedance	-10 to +10V	± 0.1% F.S.	5 kOhm	
Analog Outputs (4)	AO1, AO2, AO3, AO4 User defined measurement functions			
Range, Accuracy, Impedance	0 - 5Vdc for 0 - F.S.	± 0.1% F.S.	<10 Ohm	
DIGITAL I/O (DB25 Connector Rear Panel)				
Digital Inputs - Fixed (3)	Remote Inhibit, Transient Trigger, Phase Sync			
Digital Inputs - User (3)	DI1, DI2, DI3, Functions are user defined			
Digital Outputs - Open Collector (2)	External Relay Control to change output FORM, Relay Control for T Option			
Digital Outputs - TTL, Fixed (2)	Output Relay / Transient / Function Strobe / Phase Sync			
Digital Outputs - TTL, User (2)	DO1, DO2			
Output Voltage Levels	Low < 0.4V, High > 4.6V			
AC MAINS INPUT				
Mains Voltage Input	4 Wire, L1, L2, L3 and PE			
Frequency	47 - 63 Hz			
Input Voltage Range	-2 models: 208 ~ 240Vac ±10% -4 models: 380 ~ 480Vac ±10%			
	360AFX (6kW)	390AFX (9kW)	3120AFX (12kW)	3150AFX (15kW)
Nominal Phase Current -2 @ 208V	23 Arms	33 Arms	43 Arms	51 Arms
Nominal Phase Current -4 @ 400V	13 Arms	18 Arms	24 Arms	27 Arms
Nominal Phase Current -4 @ 480V	11 Arms	14 Arms	20 Arms	23 Arms
Peak Inrush Current	< 1.5 x Irms			
Input Power Factor	> 0.9			
Efficiency	> 85%			

Footnotes:

2: Voltage range is re-scaled as needed when T Option unit is connected

3: For RMS Currents above 2.0 A

4: For Power levels above 100 W

5: Range = 0 - 880 Vdc in Split phase mode

REMOTE CONTROL INTERFACES				
Standard Interfaces	USB Type B, LAN, GPIB / IEEE488, RS232, all on rear panel			
LAN / Ethernet Interface	LXI compliant, Ethernet, RJ45, TCP/IP Protocol, Telnet Protocol Command Line			
GPIB Functions	IEEE488.1, IEEE488.2 (2003 incl., NI HS488) IEC 60488-1, IEC 60488-2 (2004) Functions: SH1, AH1, T6, L3, SR1, RL1, DC1, DT1			
WIFI (Optional)	Optional external USB connected WIFI adapter available.			
ModBus TCP (Optional)	Uses Power Source's LAN interface to connect to CANopen Fieldbus			
CAN/CAN-FD (Optional)	Uses USB to CAN-FD adapter to connect to CAN network			
ENVIRONMENTAL				
Cooling	Variable speed fan cooled, front intake, rear exhaust			
Audible Noise @ 1 meter distance	Standby Mode:	46 dBA	Full Power:	85 dBA typical
Energy Saving Modes	Standby Mode:	Output Stages	Sleep Mode:	All power stages OFF
Temperature	Operating:	0 to 40 °C 32 to 104 °F	Storage:	-20 to 70 °C -4 to 158 °F
Humidity & Altitude	< 80%, non-condensing		2000 m / 6500 feet	
MISC. SYSTEM FEATURES				
Front Panel Display	Full Color, Touch LCD Display, 4.3" Diagonal size, 480 x 272 Pixels resolution			
USB Ports	2 on Front Panel, 1 on Rear Panel, All Type A			
SD Card	32 GB max. Capacity			
Video Output HDMI	Monitor Out, Front Panel			
DIMENSIONS & WEIGHTS				
Chassis Size H x W x D ⁽⁶⁾	7.0" x 17.0" x 25.0"		178 x 432 x 635 mm	
Shipping Package Size H x W x D	20" x 27" x 38"		508 x 686 x 965 mm	
Weight Single 4U Height Unit	Net: 111.2 lbs. / 50.4 kg		151 lbs / 68.5 kg	
REGULATORY DATA				
Safety	IEC 61010-1:2010 (Edition 3)			
EMC - Emissions	EN 55011:2009+A1:2010			
EMC - Immunity	EN 61000-4-2, EN 61000-4-3, EN 61000-4-4, EN 61000-4-5, EN 61000-4-6, EN 61000-4-8, EN 61000-4 -11			
Product Category	EN 61326-1:2013 (Measurement, Laboratory and Control Equipment)			
Agency Approvals	CE Mark NRTL Nemko on units delivered within North America or Canada only			
RoHS (DIRECTIVE 2011/65/EU)	Product Category EN50581:2012			

Footnotes:

6: Units can be zero-stacked in 19" EIA cabinet when using optional rack-slides. When using L-brackets, allow 1U space between units.

Standard Model Configurations

AFX Series AC & DC Sources come in various power levels as rack-mount, bench, or pre-wired cabinet systems. All models require three-phase AC input. Contact us for custom configurations or cabinet options.

MODEL	Phase Mode	Rated Power ⁽¹⁾ AC / DC mode	Voltage Ranges ⁽²⁾ Vac L-N / Vdc	Max. AC/DC Current ⁽²⁾ 3 & 2 Phase Mode	Max. AC/DC Current ⁽²⁾ 1 Phase Mode ⁽³⁾	Form Factor
360AFX	1, 2 & 3	6 kVA, kW / 6 kW	0-333 Vac / 0-425Vdc	16.7 Arms / 16.7 Adc	50 Arms / 50.0 Adc	4U
390AFX	1, 2 & 3	9 kVA, kW / 9 kW	0-333 Vac / 0-425Vdc	25.0 Arms / 21.0 Adc	75 Arms / 62.5 Adc	4U
3120AFX	1, 2 & 3	12 kVA, kW / 12 kW	0-333 Vac / 0-425Vdc	33.3 Arms / 21.0 Adc	100 Arms / 62.5 Adc	4U
3150AFX	1, 2 & 3	15 kVA, kW / 15 kW	0-333 Vac / 0-425Vdc	41.7 Arms / 21.0 Adc	125 Arms / 62.5Adc	4U
3180AFX	1, 2 & 3	18 kVA, kW / 18 kW	0-333 Vac / 0-425Vdc	50.0 Arms / 41.7 Adc	150 Arms / 125.0 Adc	18U
3240AFX	1, 2 & 3	24 kVA, kW / 24 kW	0-333 Vac / 0-425Vdc	66.7 Arms / 41.7 Adc	200 Arms / 125.0 Adc	18U
3300AFX	1, 2 & 3	30 kVA, kW / 30 kW	0-333 Vac / 0-425Vdc	83.3 Arms / 41.7 Adc	250 Arms / 125.0 Adc	18U
3450AFX	1, 2 & 3	45 kVA, kW / 45 kW	0-333 Vac / 0-425Vdc	125.0 Arms / 62.5 Adc	375 Arms / 187.5 Adc	18U
3600AFX	1, 2 & 3	60 kVA, kW / 60 kW	0-333 Vac / 0-425Vdc	166.7 Arms / 83.3 Adc	500 Arms / 250.0 Adc	32U
3750AFX	1, 2 & 3	75 kVA, kW / 75 kW	0-333 Vac / 0-425Vdc	208.3 Arms / 104 Adc	625 Arms ³ / 312.5 Adc	32U
3900AFX	1, 2 & 3	90 kVA, kW / 90 kW	0-333 Vac / 0-425Vdc	250.0 Arms / 125 Adc	750 Arms ³ / 375.0 Adc	32U
31050FX	1, 2 & 3	105 kVA, kW / 105 kW	0-333 Vac / 0-425Vdc	291.7 Arms / 145.8 Adc	875 Arms ³ / 437.5 Adc	42U
31200AFX	1, 2 & 3	120 kVA, kW / 120 kW	0-333 Vac / 0-425Vdc	333.3 Arms / 166.7Adc	1000 Arms ³ / 500.0 Adc	42U
31350AFX	1, 2 & 3	135kVA, kW / 135 kW	0-333 Vac / 0-425Vdc	375.0 Arms / 187.5 Adc	1125 Arms ³ / 562.5Adc	42U
31500AFX	1, 2 & 3	150 kVA, kW / 150 kW	0-333 Vac / 0-425Vdc	416.7 Arms / 208.3 Adc	1250 Arms ³ / 625.0 Adc	2x 32U
31650AFX	1, 2 & 3	165 kVA, kW / 165 kW	0-333 Vac / 0-425Vdc	458.3 Arms / 228.2 Adc	1375 Arms ³ / 687.5 Adc	2x 32U
31800AFX	1, 2 & 3	180 kVA, kW / 180 kW	0-333 Vac / 0-425Vdc	500.0 Arms / 250.0 Adc	1500 Arms ³ / 750.0 Adc	2x 32U

Note 1: Rated power shown is for Three Phase or Single Phase mode operation. For Split Phase mode, rated power is 2/3.

Note 2: Extended Voltage Range Limit. Rated Currents are full specification, nominal values. See specification section for extended operating voltage ranges.

Note 3: Contact factory for cabinet output wiring modifications to support single phase AC mode on cabinets above 60kVA.

Unit Dimensions

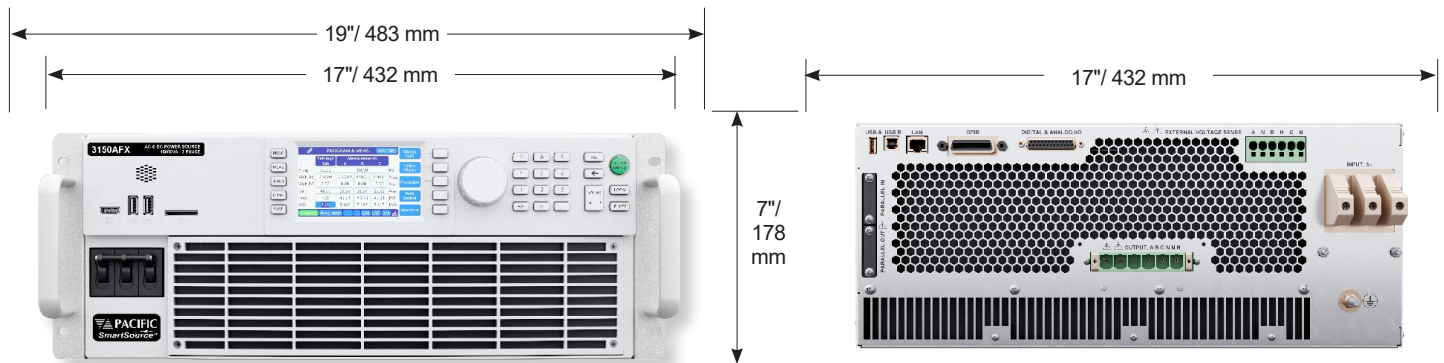

The 3150AFX is designed for bench top or 19" equipment rack operation.

The Rear Panel provides connections for AC Input, AC or DC Output, External Sense, Aux I/O and remote control interfaces.

Safety Cover & Strain Relief Kit Option

Optional kit includes covers for AC input and AC/DC output connections, with wire strain relief to prevent accidental disconnection. Easily install it on the rear panel using existing mounting studs. AC input and output wiring must be provided by the user or system integrator.

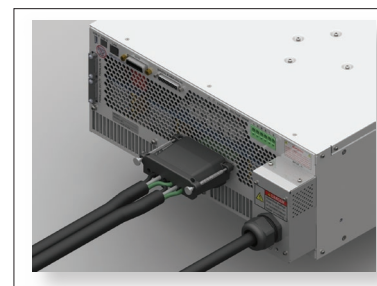

Ordering Information

Bench Models

- 360AFX
- 390AFX
- 3120AFX
- 3150AFX

Cabinet Systems¹

- 3180AFX
 - 3240AFX
 - 3300AFX
 - 3450AFX
- Systems available up to 180kVA

Alternate Voltage Range Options

- S Suffix - 600V Series Output
Requires pairs of AFX units
- T Suffix - 400V Transformer Option
Consult factory for other V ranges

Master Unit with front panel controller

- A Controller w/Analog & Digital I/O
- G GPIB Interface

Options

- B For use with ECTS2 Test Systems
- C IEC413 Interharmonics Generator
- DM Dual Master (45kVA+ models only)
- O OCS Output Control Switch
- W Wiring Isolated Output Neutrals

Auxiliary Models (No controller)

- 390AFX-2NC / 390AFX-4NC
- 3120AFX-2NC / 3120AFX-4NC
- 3150AFX-2NC / 3150AFX-4NC

Input Voltage (V_{IN})

- 2 208V - 240Vac, 3Ø ± 10%, 47-63Hz
- 4 380V - 480Vac, 3Ø ± 10%, 47-63Hz

Export Version

- E Append "E" postfix

AFX Series Model Number Encoder:

Note:

- Solid outlined fields must be specified
- Dashed outlined fields are optional.

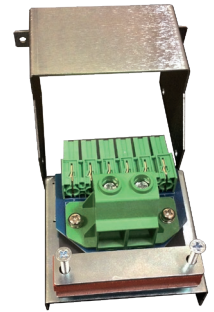
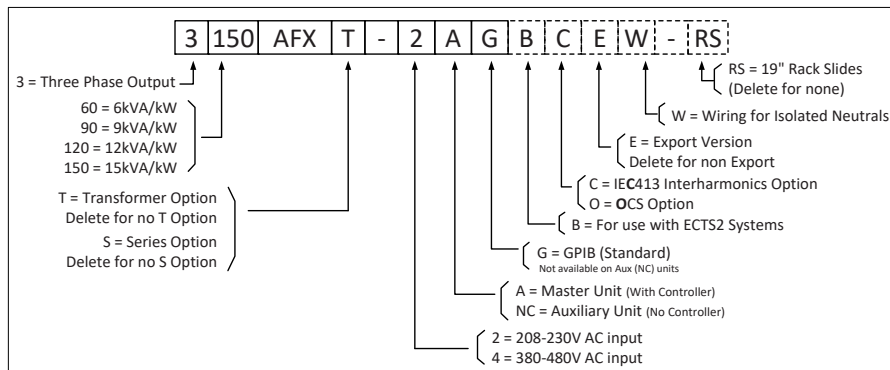

Single Phase Mode Output Adapter Option

Order Example

3150AFX-2AG

- Bench Model, 15 kVA, 3-Phase, AC Power Source with USB, RS232, LAN, GPIB & AUX I/O
- 208Vac 3 Phase Input Voltage

Typical Delivery Items

- AC & DC Power Source
- English Manuals in PDF
- Rack Mount Handles
- Certificate of Compliance

Available Accessories

- Output shorting adapter for single phase output mode use. P/N 160086
- Paralleling Cable, 1 Ft. (Included with Aux models). P/N 778036
- Rack slides. P/N 703251

Note 1:

Cabinet systems consist of one master unit and one or more auxiliary units integrated into a 19 inch EIA cabinet. Includes input and output wiring to rear mounted compression terminal blocks. Shown with optional Emergency Power Off (EPO). Customers that require the use of their own cabinets can order system kits without cabinet.

Pre-Written Test Sequence Options

Test Sequence Options require use of the built-in **SmartSource Suite** remote control platform via LAN or USB.

Test Sequences

IEC Test Suite - IEC 61000-4-11p, IEC 61000-4-14, IEC 61000-4-27p, IEC 61000-4-28, IEC 61000-4-29p and IEC 61000-4-34
 IEEE 1547.1

MIL-STD 1399-300B or 300 Part 1 - US DoD, Shipboard Power, AC Power Groups

MIL-STD 1275 Rev E

SEMI F47-0706

KS C 9610 4-11, KS C 9610-4-29

Avionic Test Sequences

ABD0100.1.8 - Airbus A380, AC & DC Power Groups
 ABD0100.1.8.1 - Airbus A350, AC & DC Power Groups
 AMD24C - Airbus A400M, AC & DC Power Groups
 Boeing 787B3-0147 - B787, AC & DC Power Groups
 MIL-STD704 - US DoD, AC & DC Power Groups
 RTCA-DO160 Section 16, AC & DC Power Groups

Toll Free: 800.854.2433
sales@pacificpower.com
www.pacificpower.com



Innovate the Way You Test

by making it simpler, safer, more productive, and sustainable.



Global Sales & Service Centers

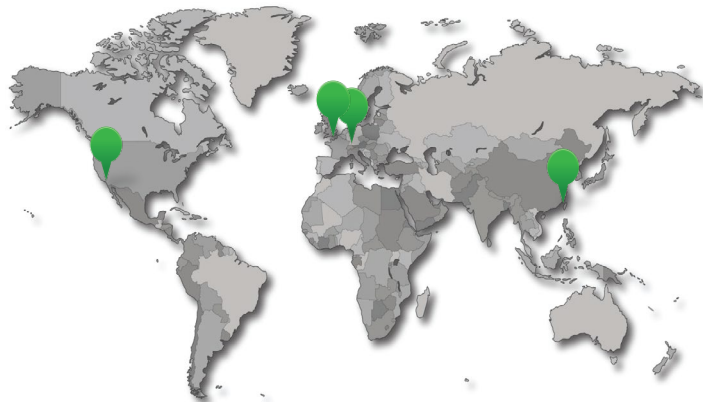

The Power of Expertise

About Pacific Power Source

Founded in 1971, Pacific Power Source is an industry leading manufacturer of AC and DC power test solutions. Our reputation as a market and technology leader stems from our best-in-class products, commitment to R&D investments, and exceptional worldwide customer support.

Pacific Power Source is a PPST Solutions Company.

AMERICAS & INTERNATIONAL

**Pacific Power Source
Irvine, USA**

Phone: +1(949) 251-1800
Fax: +1 (949) 756-0756
sales@pacificpower.com

EUROPE

**Pacific Power Source EU
Kappelrodeck, Germany**

Phone: +49 7842 99722-20
Fax: +49 7842 99722-29
info@pacificpower.eu

UNITED KINGDOM

**Caltest Instruments
Petersfield, UK**

Phone: +44 (0) 1483 302 700
sales@caltest.co.uk

CHINA

**PPST Shanghai
Shanghai, China**

Phone: +86-21-6763-9223
Fax: +86-21-5763-8240
info@ppst.com.cn