

## Introducing the ELZ Series

### The Industry's Most Powerful, Flexible, and Intelligent Regenerative AC & DC Electronic Load



Regenerative



PHIL Interface Option

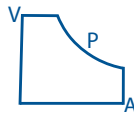

Constant Power



High Current

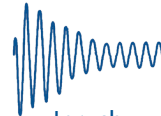

Inrush Current Control

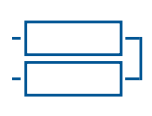

Scalable Power

## Key Features

- Regenerative Electronic Load
  - » 4-Quadrant AC & DC Load
  - » Fully Programmable
- High Power – Up to 55kW per Cabinet; Parallel Multiple Cabinets up to 550kW
- AC, DC and AC+DC Capability
- Single, Split, Three-Phase; Multi-Channel Configurations
  - » Isolated Neutrals Independent Channel Modes
- Dual Constant Power Voltage with Wide Operating Range
  - » AC Voltage Ranges: 5-220 V LN / 9-380 V LL, and 5-440 V LN / 9-760 V LL
  - » DC Voltage Ranges: 0-335 Vdc and 0-650 Vdc
- Wide Frequency Range 15Hz - 1000Hz
- Galvanic Isolation from Facility AC Input to Load Input and Between Input Phases / Channels
- Dynamic, Quiet and Efficient Operation Using Silicon Carbide (SiC) Based Technology
- High Speed Waveform Capture and Scope Display
- Powerful Current Transient Programming Tools
  - » Generate Harmonics and Interharmonics Currents
  - » Analog I/O Signals Standard
- High Speed Analog I/O for PHIL Mode (Option H)
- **SmartSource Suite:** Web Browser Control

## ELZ Series

### Regenerative 4-Quadrant AC and DC Load

The ELZ Regenerative Load Simulator is designed to emulate real-world normal and abnormal load conditions for testing a wide range of AC or DC power generating or conversion equipment. The ELZ's high-power provides 30kVA/kW up to 55kVA/kW in a single cabinet and can parallel up to 550kVA/kW using multiple cabinets and supports power hardware-in-the-loop (PHIL) applications.

The ELZ Series' flexible channel input modes and advanced control and programming capabilities make it ideal for generating complex user-defined load conditions.

Full operator control of current, power and power factor allows for testing a wide range AC or DC power sources. The ELZ can also support testing your Power Generating Equipment to regulatory and safety compliance standards.

### Application Examples:

- EV Charger Load Testing, On Board Chargers (OBC), Wallboxes, V2G, V2H, V2X, and EV Charging Cables
- Solar PV/Grid-Tied Inverters RLC Loading for Anti-Islanding
- Energy Storage Systems (ESS), Home ESS Load Testing
- UPS Products and PDUs AC Load Testing
- EV Battery Discharge Testing
- Power Hardware in the Loop (PHIL) Simulations
- Aerospace Power and Converter Testing
- Utility Power Quality and Grid Usage



Flexible Control

# Dual Constant Power Voltage Input Ranges

The ELZ series supports both low and high voltage ranges for either AC or DC mode. In AC mode, constant power mode is available from 52% of full scale voltage to 100% of full scale input voltage as shown in Figure 1 & 3 below.

This allows for higher load currents from the UUT at lower than full scale voltage than would otherwise be possible. For voltage settings below 52% of full scale, current remains at max. rated current.

In DC mode, constant power is available from 50% of full scale voltage to 100% of full scale as shown in Figure 2 & 4 below.

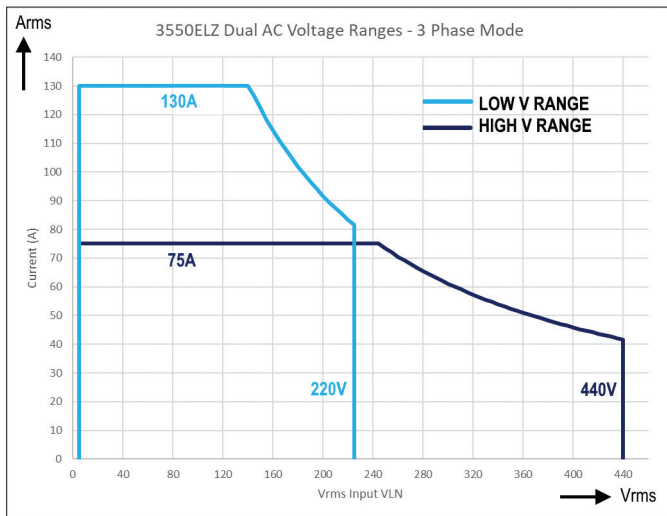

Figure 1: High and Low AC Voltage Ranges - Current vs. Voltage - 55kW

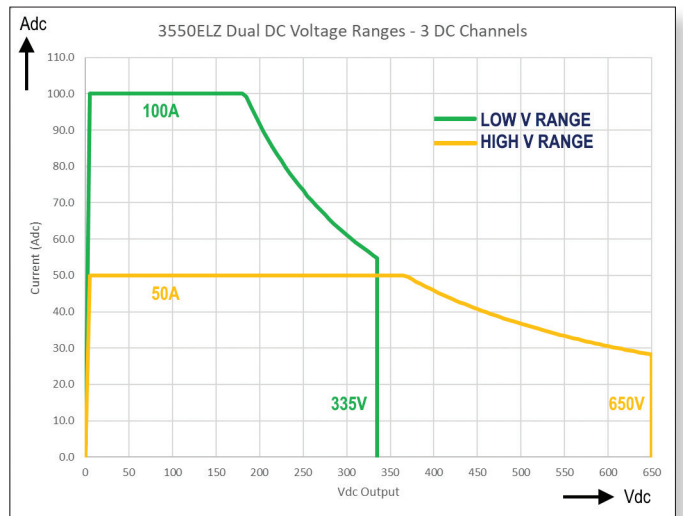

Figure 2: High and Low DC Voltage Ranges - Current vs. Voltage - 55kW

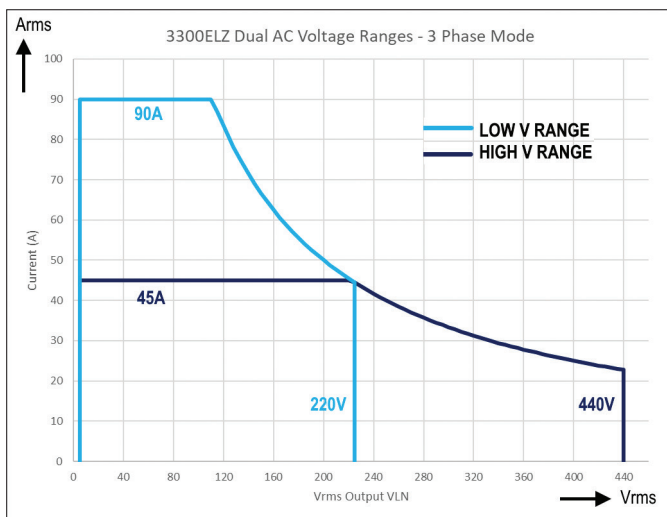

Figure 3: High and Low AC Voltage Ranges - Current vs. Voltage - 30kW

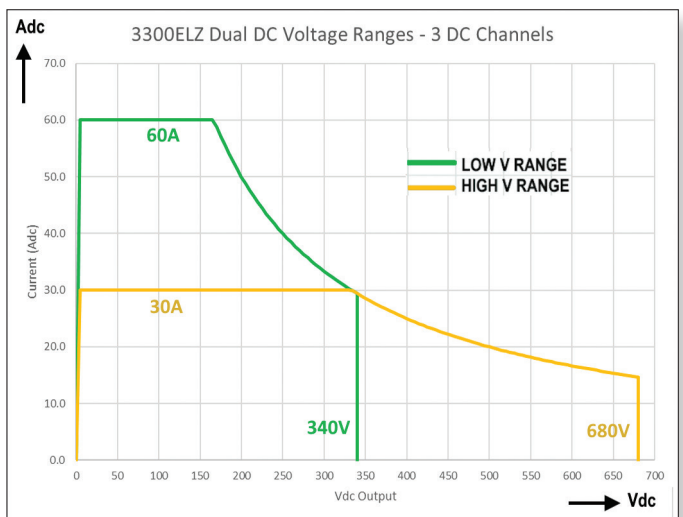
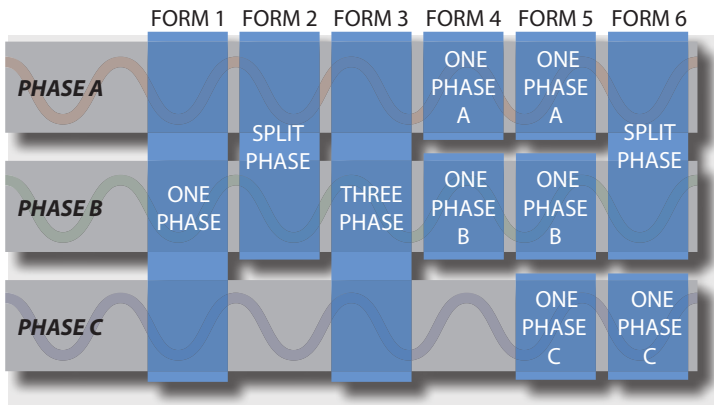

Figure 4: High and Low DC Voltage Ranges - Current vs. Voltage - 30kW

# Ultimate Flexibility With Six Input Configurations



## Simultaneous AC & DC Operation on Individual Phases and Automatic Switching of Operation Modes

In addition to the conventional single, split and three phase modes, the ELZ also supports fully independent modes for either 2 or 3 'channels'. In these modes, each channel can be set to have a different operation mode (i.e. CC, CP, CR etc.) ELZ Loads come factory configured with three isolated neutrals (NA, NB and NC) to allow connection of either Delta or WYE power sources.

## Power HIL Support (Option H)

To support integrated test system design, the ELZ Series offers a standard suite of analog and digital I/O functions. The user can assign command macros or setting parameters to analog or digital I/O pins as needed. This provides a unique level of customization for putting together sophisticated test stations.

By adding the H Option, the ELZ can be used as a load for PHIL Applications. This analog interface provides high speed input for controlling current level and current waveshape. Amplifier latency is typically less than 50 usec. Voltage and Current capture signals are returned to the simulation system. These analog I/O lines can be connected to commercially available HIL systems.

## PHIL Simulation Workflow

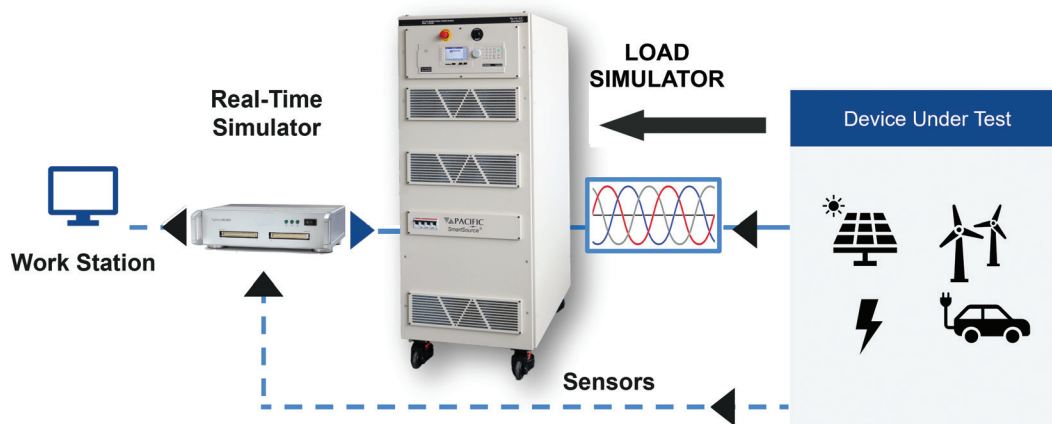

## Regenerative Power Saves Significant Energy and Costs

Regenerative Electronic Loads provide energy efficiency and significant cost savings by returning energy back to the facility or the grid rather than converting it to heat. Compared to dissipative loads, the ELZ produces less heat, ensures a stable testing environment for reliability and reduces the need for additional cooling systems. Regenerative bidirectional power flows are critical for simulating real-world conditions in transportation and renewable energy systems.

# Powerful Waveform & Measurement Tools

The ELZ has a built-in waveform digitizer and fast transient capabilities at 100  $\mu$ sec time resolution, supporting LIST, PULSE and STEP modes. Current waveform generation includes ten Standard, Sine, Square, Triangle, Clipped, Harmonics and Inter-harmonics.

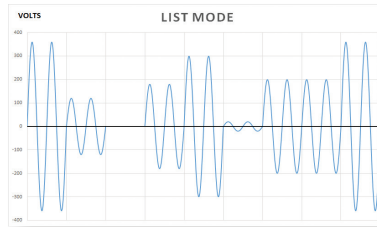

List Mode

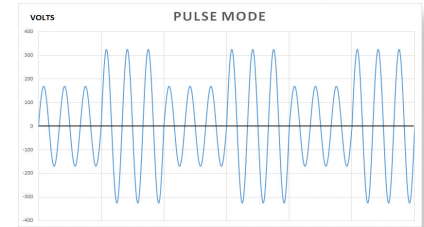

Pulse Mode

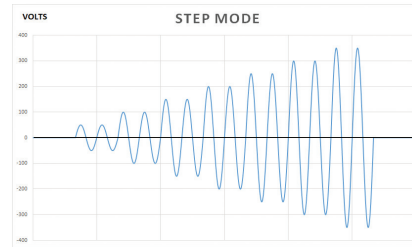

Step Mode

The waveform digitizer is complemented by a digital measurement system with scope function. Capture advanced measurements and waveforms.

## Fully Test AC Power with 4-Quadrant Load

The ELZ Series supports testing PV inverters, V2G, EV Chargers, EVSE, batteries, UPS, and AC/DC power supplies. A key advantage of the ELZ Regenerative Load is its ability to operate in all four quadrants using programmable phase shift in CC or CS modes.

Compared to 2-Quadrant non-regenerative AC loads, the ELZ allows simulation of inductive and capacitive loads to fully test AC power sources, as shown in the leading and lagging power factor examples.

This Regenerative Electronic Load capability provides several AC and DC operating modes to push the boundaries of test. Simulate linear and non-linear loads (rectified), inductive and capacitive loads.

**AC Modes:** Constant Current, Constant Power & Apparent Power, Constant Resistance, Constant Voltage, CC+CR, CC / CS Rectifier Mode 1 $\phi$  & 3 $\phi$  and Circuit Emulation modes for multiple R, L and C network topologies

**DC Modes:** Constant Current, Constant Power, Constant Resistance, Constant Voltage, CR+CC

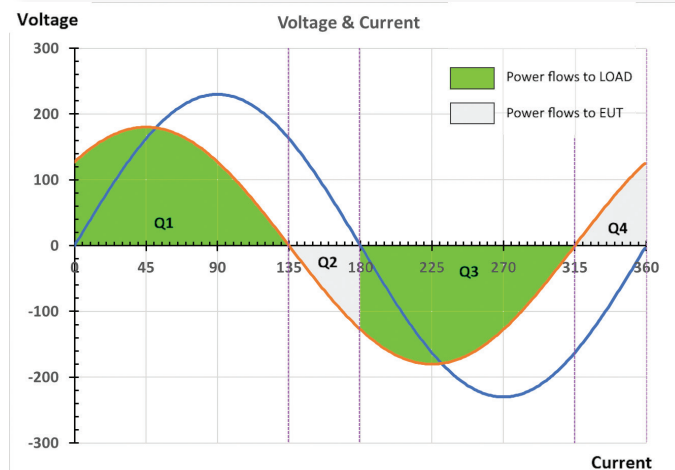
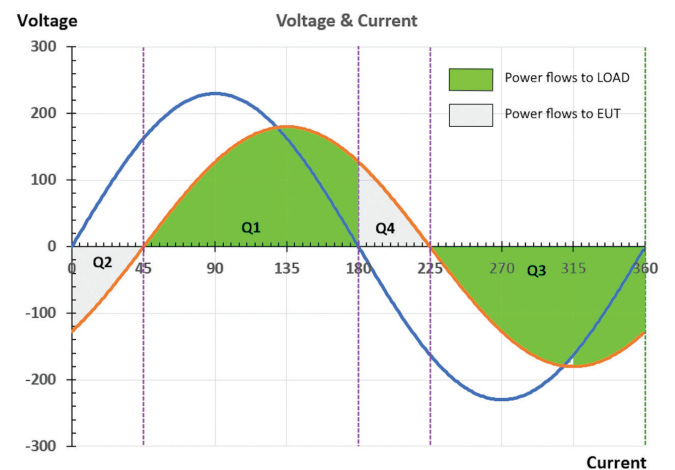

# User Friendly Control Options

Multiple integrated control options include:

- Intuitive Touch Screen LCD Display with Soft Key driven Menus
- SmartSource Suite Web Interface
- LAN, GPIB, RS232 & USB Interfaces, and ModBus (optional)
- Supports external touch screen monitor via Video Output Interface

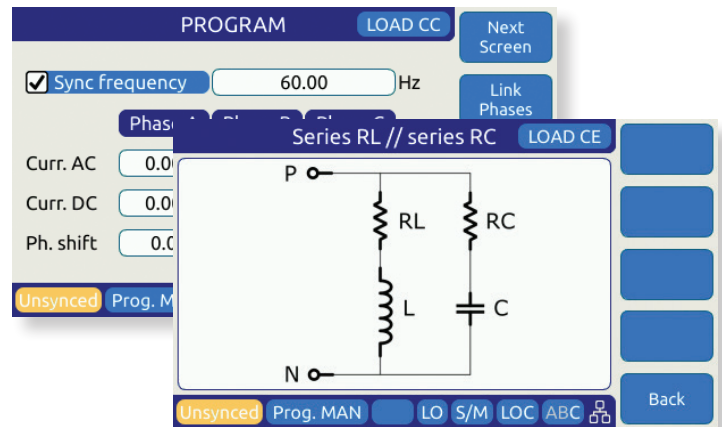

## Simplify Test Automation with SmartSource Suite Remote Control Platform

Easily monitor, control, and manage testing with the ELZ's SmartSource Suite remote control platform. Use the embedded, web browser interface with real-time control. Access control panels and test sequences on-premises or on any mobile device (laptop, phone, tablet) via secure client access.

- Full control and measurement capability
- Program settings and measurement read back including digital scope and harmonics data
- Extensive safety protection settings
- Waveform selection, preview and edit modes
- Execution of user's custom test sequences
- Transient data entry and execution screen using a spreadsheet layout

## Built-in Galvanic Isolation Reduces Safety Risks

The ELZ provides both facility-to-load input isolation, and phase to phase or channel to channel isolation. Galvanic isolation provides complete separation between the grid and load input so there is no electron flow between channels. Channel to channel isolation provides flexibility to use each phase as its own independent load with full current and power control. The ELZ's fully isolated design reduces safety risks for the operator and prevents unexpected UUT damage by preventing unwanted current or ground loops. This built-in capability doesn't require an external transformer which saves significant costs and space.

# Extensive Load Modes & Features

The ELZ Series offer an extensive range of programmable load operating modes in addition to a multitude of features including **circuit emulation mode**, to support a wide range of load conditions as shown here.

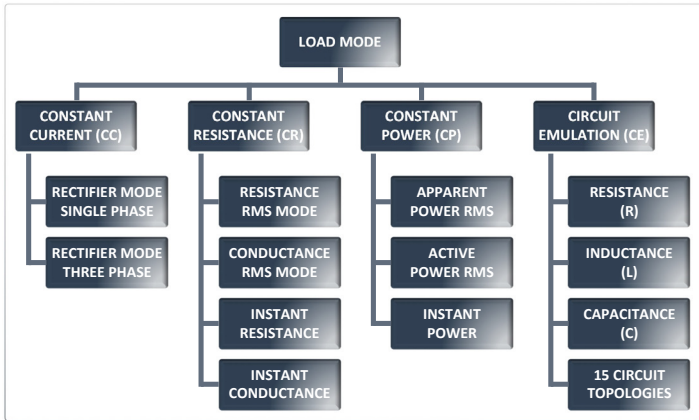

Available ELZ Load Operating Modes

Features	CC Mode	CR Mode	CP Mode	CE Mode
User Waveform	✓	✓	✓	
Rectifier Waveform	✓	✓	✓	
Current Harmonics	✓			
Current Inter Harmonic	✓			
Sync Mode	✓	✓	✓	✓
Transient Programming	✓	✓	✓	
AC, DC & AC+DC Mode	✓	✓	✓	✓
Analog Input Programming	✓	✓	✓	

Available Features for each Load Mode

## Parallel Load Systems up to 550kW

The ELZ Series provides modular and scalable power to meet changing test requirements. Easily parallel multiple cabinets to achieve higher power. Cabinets can be paralleled up to 550kW. Its top vent, air-cooled design allows the flexibility to place the ELZ cabinets against a wall or back-to-back if needed, maximizing floor space. This robust solution also has a built-in line transformer and EMI input filters that provides galvanic isolation between the grid and the unit under test, which is ideal for use in environments where grid power may be highly distorted or 'dirty'.

## ELZ Cabinet Dimensions

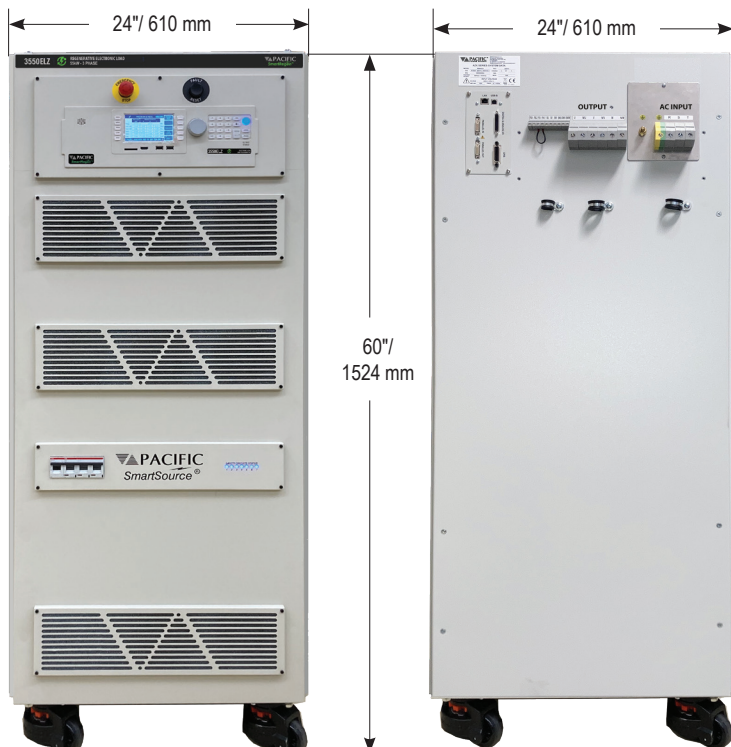

The ELZ is housed in a custom floor standing cabinet on locable casters for easy of movement and placement.

Depth of the cabinet is only 32.0 inches / 813 mm and not clearance is required behind the ELZ cabinet rear as air is vented out through the top of the cabinet.

The ELZ Rear Panel provides connections for AC Input, AC or DC EUT Connections, External Sense, Aux I/O, remote control interfaces, parallel bus connections and optional HIL Interface connector.

A safety cover for all power connections is included with each unit (not shown).

# Technical Specifications

MODEL:	3300ELZ	3450ELZ	3550ELZ
<b>Modes of Operation</b>			
Regenerative Grid Simulator, Regenerative DC Power Source. Regenerative Electronic Load optional			
<b>AC or DC Output</b>			
Phase Modes (Form)	1, 2 or 3	1, 2 or 3	1, 2 or 3
Maximum Power (Total)	30 kW/kVA	45 kW/kVA	55 kW/kVA <sup>1</sup>
Per Phase / Channel	10 kW/kVA	15 kW/kVA	18.3 kW/kVA
<b>Voltage</b>			
Range	AC High Range: 5 - 440 V <sub>LN</sub> / 9 - 760 V <sub>LL</sub>   DC High Range: 9 - ±650 V <sub>DC</sub> AC Low Range: 5 - 220V <sub>LN</sub> / 9 - 380 V <sub>LL</sub>   DC Low Range: 0 - ±335 V <sub>DC</sub>		
Resolution	0.01 V	Accuracy	± 0.1% F.S
Harmonic Distortion R Load	< 100 Hz: < 0.2%, 100~1000 Hz: < 0.2% + 0.125%/100Hz		
Load Regulation	± 0.02% (CSC Mode)	Line Regulation	< 0.1% for 10% Line Change
Phase Angle - Range (B, C)			
<b>Maximum Current</b>			
Three Phase modes AC / DC	45.0 Arms / 30.0 Adc	65.0 Arms / 40.0 Adc	75.0 Arms / 50.0 Adc
Split Phase modes AC / DC	68.0 Arms / 45.0 Adc	72.0 Arms / 45.0 Adc	75.0 Arms / 50.0 Adc
Single Phase mode AC / DC	135.0 Arms / 90.0 Adc	195.0 Arms / 120.0 Adc	225.0 Arms / 150.0 Adc
Max. Peak Current per phase (AC)	Low Vac Range: 360Apk / High Vac Rang: 180Apk		
<b>Frequency</b>			
Range	DC, 15 Hz – 1000 Hz	Resolution / Accuracy	0.01 Hz / ± 0.005% (50 ppm)
<b>AC Input</b>			
Input Voltage Range / Freq	380Vac – 400Vac (-4) or 480Vac (-8) ± 10%, 4 Wire, L1, L2, L3 and PE / 47 - 63 Hz		
Nom. Phase Current @ 400Vac / 480Vac	54 Arms or 43 Arms	80 Arms or 65 Arms	100 Arms or 80 Arms
Input Power Factor	> 0.99 @ Full Load	Efficiency	90 %
<b>Measurements</b>			
Vrms Range / Accuracy	0 – 480 V <sub>LN</sub> / 0-830 V <sub>LL</sub> / 0.1% F.S.		
Irms Range / Accuracy	High Range: 0-130 Arms, Low Range: 0-75 Arms / ± (0.25% + f (kHz) * 0.25%) F.S.		
Power Range / Accuracy	0 - 30 kVA / ± 0.75 % F.S.	0 - 45 kVA / ± 0.75 % F.S.	0 - 55 kVA / ± 0.75 % F.S.
Frequency Range / Accuracy	15 Hz - 1000 Hz / 0.1% Rdg	Resolution	0.01 Hz
<b>Transient Functions</b>			
Programming	200 Steps / 400 Segments, LIST, PULSE & STEP Modes, Frequency, Volt AC, Volt DC, Waveform, Ramp Time, Dwell Time. Time range: 0.1 - 10000000.0 ms, Time resolution 0.2 ms		
Execution	Run from step # to step #, Run, Step, Restart, Stop	Program Storage:	Non-volatile, 100 Programs + Transients
<b>PARAMETERS / FUNCTIONS SPECIFICATIONS</b>			
<b>Remote Control Interfaces</b>			
Standard	USB Type B, LAN (LXI), GPIB / IEEE488, RS232, all on rear panel		
Optional	External USB WIFI adapter / ModBus TCP / CAN/CAN-FD		
<b>Analog &amp; Digital I/O</b>			
Analog I/O Inputs / Outputs	In: Voltage phs A,B,C & Frequency / Out: Analog Out: Vmeas A, B, C, Pmeas all Phases		
Digital I/O Inputs / Outputs	In: Remote Inhibit, Trans. Trig., Phase Sync, User / Out: Output Relay, Transient, Function Strobe, Sync		
PHIL Interface (Option H)	Inputs: 3 (Voltage or Current Programming), Outputs: 6 (Voltage and Current), ±10V or ±16V		
<b>Environmental</b>			
Cooling	Variable Fan Speed, Front Air Intake, Top Exhaust		
Temperature Operating	0 to 40 °C / 32 to 104 °F	Temperature Storage	-20 to 70 °C/-4 to 158 °F
Humidity	< 80%, non-condensing	Altitude	2000 m / 6500 feet
<b>System Features</b>			
USB Ports	2 on Front Panel, 1 on Rear Panel, All Type A		SD Card: 32 GB max. Capacity
<b>Dimensions &amp; Weights</b>			
Chassis Size H x W x D	59.8" x 24.0" x 31.9" / 1520 x 610 x 810 mm   Crated: 71" x 32" x 44" / 1520 x 610 x 810 mm		
Cabinet Weight	517 Kg / 1140 lbs	Shipping Weight:	592 Kg / 1305 lbs
<b>Regulatory Compliance</b>			
Safety	IEC 61010-1:2010 (Edition 3)		
EMC - Emissions / Immunity	EN 55011:2009+A1:2010 / EN 61000-4-2, -4-3, -4-4, -4-5, -4-6, -4-8 and EN 61000-4 -11		
Product Category	EN 61326-1:2013 (Measurement, Laboratory and Control Equipment)		
Agency Approvals	CE Mark	RoHS (2011/65/EU):	EN50581:2012

# Ordering Information

## ELZ Series Models

Single Cabinets	Parallel Systems	Input Voltage (V <sub>IN</sub> ) Identifier	Options
3300ELZ	3900ELZ	-4 380-400Vac 3 $\phi$ $\pm$ 10%, 47-63Hz	C Interharmonics Generator
3450ELZ	31100ELZ	-8 480Vac 3 $\phi$ $\pm$ 10%, 47-63Hz	D Safety Performance Level D
3550ELZ	31650ELZ		H Real Time I/O for PHIL
	32200ELZ		

Note 1: Contact Factory for higher power ELZ system configurations.

### Order Example 3550ELZ-4

- ELZ Cabinet, 55 kVA, 3-Phase, Regenerative Load Simulator, 380~400Vac grid connection

### Typical Delivery Items

- Electronic Load
- Cert. of Compliance

### ELZ Model Configurator

Dashed boxes are optional.

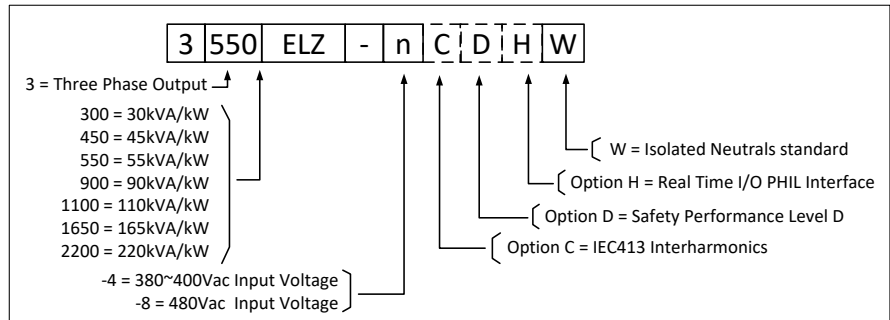

# Service & Support

## NORTH AMERICA

Pacific Power Source, Inc.  
Irvine, USA

Phone: +1(949) 251-1800

Fax: +1 (949) 756-0756

Email: [info@pacificpower.com](mailto:info@pacificpower.com)

Web: [www.pacificpower.com](http://www.pacificpower.com)

## EUROPE

Pacific Power Source  
Europe GmbH.

Kappelrodeck, Germany

Phone: +49 7842 99722-20

Fax: +49 7842 99722-29

Email: [info@pacificpower.eu](mailto:info@pacificpower.eu)

Web: [www.pacificpower.eu](http://www.pacificpower.eu)

## UNITED KINGDOM

Caltest Instruments Ltd.  
Petersfield, UK

Phone: +44 (0) 1483 302 700

Email: [sales@caltest.co.uk](mailto:sales@caltest.co.uk)

Web: [www.caltest.co.uk](http://www.caltest.co.uk)

## CHINA

PPST Shanghai Co. Ltd.  
Shanghai, China

Phone: +86-21-6763-9223

Fax: +86-21-5763-8240

Email: [info@ppst.com.cn](mailto:info@ppst.com.cn)

Web: [www.ppst.com.cn](http://www.ppst.com.cn)

2802 Kelvin Avenue, Suite 100  
Irvine, CA 92614 -5897 USA  
Phone: +1 949.251.1800  
Fax: +1 949.756.0756  
Toll Free: 800.854.2433  
E-mail: [sales@pacificpower.com](mailto:sales@pacificpower.com)  
Web: [www.pacificpower.com](http://www.pacificpower.com)