

TESTING PV MICRO INVERTERS USING A FOUR QUADRANT CAPABLE PROGRAMMABLE AC POWER SOURCE FOR GRID SIMULATION

Abstract

This application note describes the four quadrant mode of operation of a linear AC Power Source and how this mode is ideally suited for photo-voltaic (PV) inverter development and test applications. As one of the few remaining mainstream manufacturers of linear AC Power Sources, Pacific Power Source offers a unique selection of sources over a range of power levels. In this application note, the widely used 2KVA, 3 phase model 320AMXT-UPC32 is used to illustrate current source and sink capability.



Figure 1: 320AMX Linear AC Power Source

Introduction

To meet the growing demand for energy, many renewable energy sources are being deployed to augment traditional fossil fuel and nuclear based forms of power generation. Solar inverters – also known as Photovoltaic inverters or PV inverters – play an important role in this context as they convert the direct current (DC) produced by one or more solar panels into alternating current (AC) that can be used to drive typical household or industrial loads.

Modern panels using 6" solar cells have 60 cells in series producing about 30Vdc under optimal conditions. Multiple panels are normally connected in a series string to produce anywhere from 300Vdc to 600Vdc. Such installations rely on a large, centralized string inverter that converts the DC current from this string to produce sufficient AC power to service the load. Power ratings for these centralized inverters are typically 3000W or higher.

In recent years, the distributed approach of using smaller individual inverters to service only one solar panel has become a growing trend. The AC outputs of several of these so called micro-inverters are combined on the AC line to produce the desired total power. Advantages of this de-centralized approach include:

- Each micro inverter handles 250W of power, eliminating the need for forced air cooling therefore reducing cost, enhancing reliability, and extending the life of the solar installation.
- Each inverter can operate at the maximum power point for the panel it serves. In centralized inverter installations, series connected panels will have equal current flow. Therefore, not all panels will operate at their maximum power point as clouds; shadows and dirt build up affect individual panels differently.
- Simplified installation: Attaching these compact inverters to the back of each solar panel eliminates the need to use dangerous high voltage DC wiring.
- Future expansion of a micro-inverter based system is relatively easy as individual panels and inverters can be added one at a time as capacity needs to increase.
- With multiple small inverters you have greater reliability. When one micro inverter fails, the remaining micro inverters continue to operate providing solar installation power at a slightly reduced level.

As with any technology, there are some trade-offs as well. Cost per watt for micro-inverters tend to be somewhat higher than for a string inverter at a given power level. As the size of the solar installation increases, centralized string converters become more cost effective. However, for most residential installations, micro-inverters are a great alternative and their use is rapidly growing.



FREQUENCY CONVERSION



AEROSPACE



R & D



MILITARY



MANUFACTURING



CUSTOM

PV Inverter Test Requirements

PV inverters are subject to multiple safety and electromagnetic compatibility regulations. The same regulatory standards apply to micro-inverters. Since PV inverters are generally grid-tied, strict guidelines have been established to ensure the presence of a multitude of grid-tied inverters do not cause disruptions on the public utility grid. Typical examples of these regulatory standards are:

Standard	Description
IEEE 1547 / IEEE 1547.1	Standard for Conformance Test Procedures for Equipment Interconnecting Distributed Resources with Electric Power Systems
UL 1741	Standard for Inverters, Converters, Controllers and Interconnection System Equipment for Use With Distributed Energy Resources
IEC 61000-3-15	Electromagnetic immunity and emission requirements for dispersed generation in LV networks

Table 1: PV Inverter Test Standards

While IEEE and UL standards are concerned primarily with safety aspects such as leakage current and anti-islanding operation, the IEC standard also incorporate requirement for emission (harmonics and flicker) and immunity (voltage dips, low voltage ride through and frequency variations). References are made to generic IEC standards like IEC 61000-3-2/12 (Harmonics), IEC 61000-3-3/11 (Flicker), IEC 61000-4-11/34 (Voltage dips and variations), IEC 61000-4-28 (Frequency variations) etc.

Evaluating and testing micro inverter for compliance with these regulations in both the product development and manufacturing stage of the product life cycle requires the use of a precision programmable AC Power Source. What makes testing PV inverters with an AC Power Source different from most regulatory tests is the fact that unlike most products which only demand power (appliances, heaters, lights); PV inverters are generators of power.

PV testing requires that you literally connect the output of one AC Power Source into the AC output of another. This concept is referred to as "back driving". "Back driving" current into an AC Power Source can cause it to shut down. To avoid shutting down, an AC Power Source capable of four quadrant operation (bidirectional), an external load or both are required.

Four Quadrant Operation

As previously stated, most AC Power Sources support two quadrant operation, as illustrated in Figure 2. While both voltage and current can be positive or negative, the Power Factor is always positive. This is true in particular for most PWM switching design based AC Power Sources.

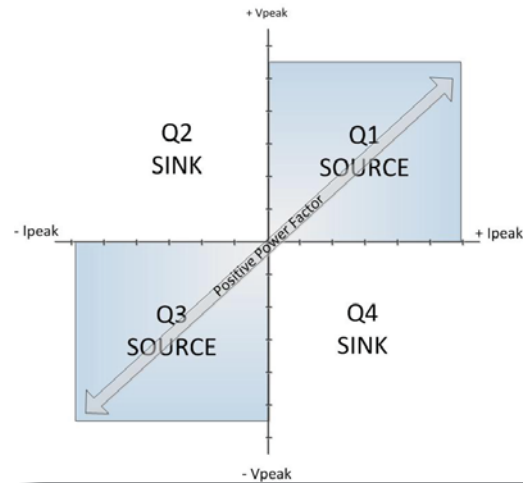

Figure 2: Two Quadrant Power Source Operation

A four quadrant AC Power Source like the Pacific Power Source AMX series on the other hand uses a push/pull linear amplifier capable of both sourcing and sinking current. This design allows the load power factor to transition between positive (source operation) and negative (sink operation) values. A true -1 to +1 Power factor capability is thus possible as shown in Figure 3.

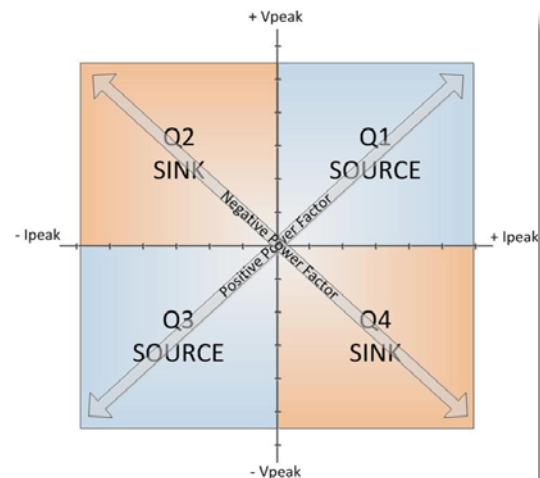

Figure 3: Four Quadrant Power Source Operation

By observing the AC voltage and current waveforms on an oscilloscope, it is readily apparent when an AC Power Source is operating in current sink mode as the current will be 180° out of phase with the AC voltage.

This is illustrated in Figure 4 where a PV micro-inverter is back driving the AC Power Source used to simulate the utility grid. It is easy to see that whenever the voltage is positive, the current is negative and vice versa. A 'normal' (positive) unity power factor AC load on the other hand would have both voltage and current with no phase shift between them.

If not dissipated by an external load, an AC Power Source operating in quadrant Q2 and Q4 will need to somehow absorb the energy coming back from the inverter under test. This can either be done by regenerating this energy onto the AC utility line using an active inverter connection to the grid or by dissipating this energy. A regenerative grid connected approach requires more complex switching technology which not only increases the cost of the product but more importantly adds a level of complexity that tends to result in reduced reliability and Mean Time Between Failures (MTBF).

More importantly, when used in a grid-tied regenerative mode, the AC Power Source falls under the same regulatory requirement as PV inverters and most AC Power Sources are not certified to be operated this way.

A dissipative mode of operation is conceptually simpler and allows seamless transitions between sink and source modes. However, it does result in additional heat generation. Consequently, the maximum amount of power that can be absorbed by the AC Power Source is less than the amount of power that can be sourced.

The Pacific Power Source AMX series is an example of a four quadrant linear amplifier that can absorb about 25% of its maximum rated power in current sink mode. To determine the operating range of the AMX series in this mode of operation, a series of tests were conducted using a set of micro-inverters.

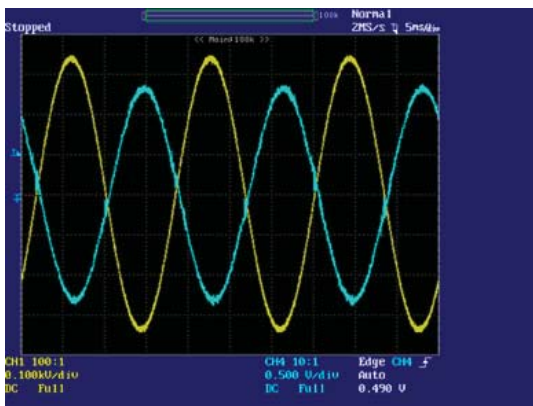

Figure 4: Negative Unity Power Factor Operation V/I Waveforms

Heat Sink Temperature Profiles in Source Mode

In order to determine the safe operating envelope in current sink mode, a series of load tests were performed at increasing power levels from light load to full load. These tests established a base line set of data for normal operation of the 320AMXT-UPC32 AC Power Source into a unity power factor load (PF = 1.0).

The information is presented as the relationship between the AMX's internal heat sink temperature and the amount of power delivered to the load during normal (source mode) operation. The table and graphs below document the heat sink temperature as the amount of power (AC current) was varied.

Nominal 240Vac single phase was achieved by placing two amplifiers (phase A & B) of the three phase 320AMXT-UPC32 in series (Phase B offset to 180° with respect to phase A) to create the split-phase power form commonly used in the United States. Each amplifier was then instrumented to measure heat sink temperatures as a load was applied.

Note: Split phase mode was used in this test in order to maximize the current applied to each amplifier. In other applications a single phase configuration with a 230Vac output voltage setting may be more appropriate.

The data collected during this normal mode of operation is shown in Table 2 and Figure 5. Clearly the heat sink temperature rises as the load is increased but never reaches an over temperature condition as the power amplifiers are sized to deliver full power indefinitely.

VAC (Vrms)	Load Current (A)	Power (W)	Heat Sink Temp (% of Shutdown Temp)	
			Phase A	Phase B
240	.940	225.60	47.1%	46.7%
240	1.911	458.64	63.3%	64.8%
240	2.919	700.56	65.4%	64.9%
240	3.981	955.44	67.2%	67.4%
240	5.000	1200.00	70.4%	70.2%
240	5.940	1425.60	77.4%	77.2%

Table 2: Heat Sink Temperature as Function of Load – Source Mode

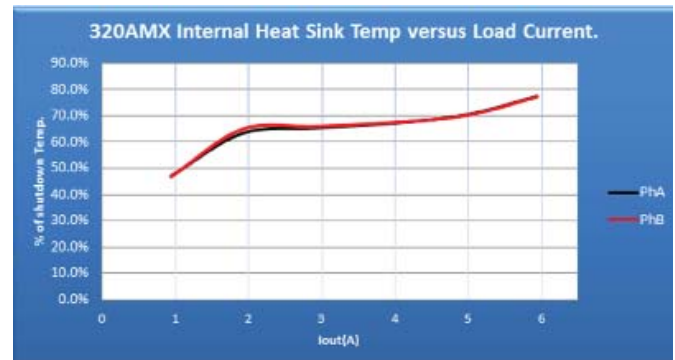

Figure 5: Temperature versus Current – Current Source (Normal) Operation

Test Setup

A set of two micro-inverters were used to produce up to 500W of AC power from a set of TDK-Lambda Genisys DC power supplies. These power supplies take the place of an actual solar panel as it is easier to control the VI curve operating point and similar varying luminance and irradiation levels this way.

To simulate the AC utility grid, a Pacific Power Source 320AMXT (three phase output) AC Power Source in a split phase configuration was used to simulate 240Vac. To control the amount of power being pushed in the AMX, a parallel resistive load bank was inserted between the inverter outputs and the AC Power Source. By increasing or decreasing the parallel load value, the amount of current absorbed by the AC Power Source versus the resistive load can be controlled. This setup is shown in Figure 6.

At the on-set of the test, the AC Power Source is supplying power only to the resistive load that is present. The micro-inverter will be in a high impedance state until it senses suitable DC power is available. As DC power is applied to the micro-inverters DC input, the micro-controller starts to synchronize to the simulated AC utility power provided by the 320AMXT-UPC32 AC Power Source. If the voltage and frequency sensed are within acceptable range, the micro-inverter will start up.

This process can take several minutes. During startup, the micro-inverter will gradually ramp up the amount of current delivered until it reaches the MPP, maximum power point of the available PV panel. In this case, the PV panel for each of the two micro-inverters used is provided by the Lambda DC supplies – one for each micro inverter – so no dynamic MPP tracking is needed. This start up sequence is shown in Figure 7. The AC voltage provided by the AMX Power Source is in yellow and the current is shown in blue.

The heat sink temperature under current sink conditions rises quickly once the micro-inverter starts pushing 1.4A of RMS current into the AC Power Source. The temperature rise over time as a percent of the heat sink temperature trip point is shown in Figure 8. After 15 minutes, the heat sink temperatures reach thermal equilibrium and the AC Power Source demonstrates the ability to continuously operate at this level.

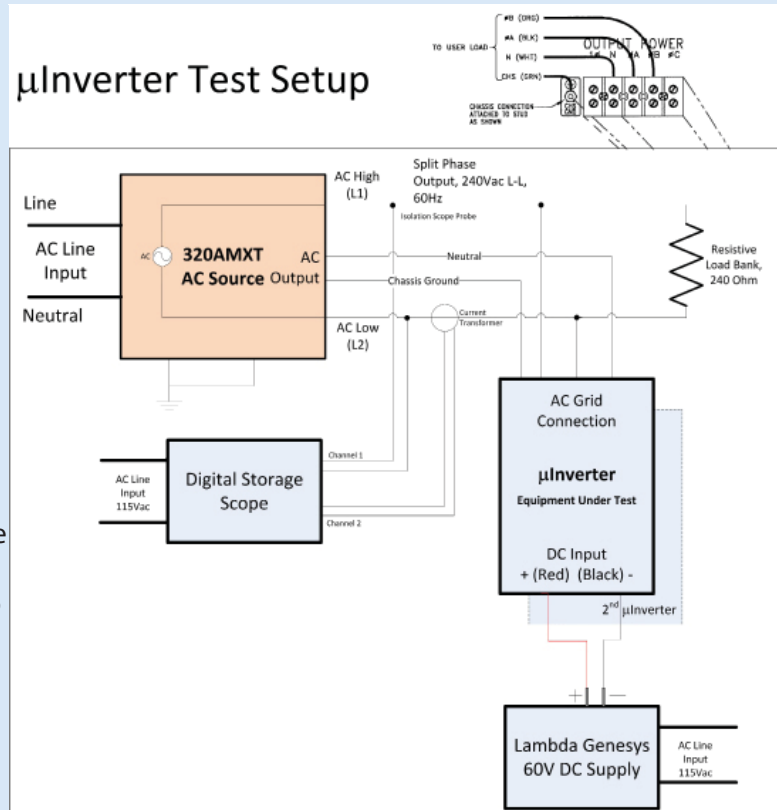

Figure 6: Micro Inverter Test Setup

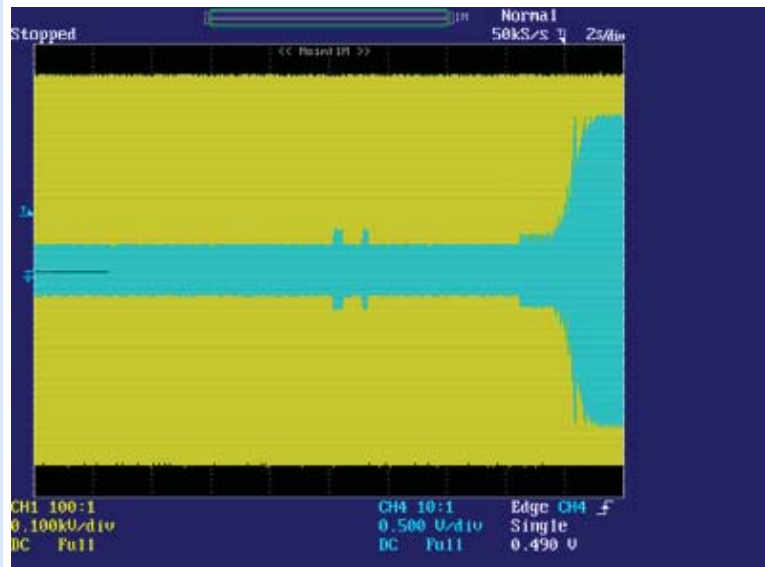

Figure 7: Micro Inverter Start Up Current

Heat Sink Temperature Profiles in Sink Mode

Using the test setup described in figure 6, the same heat sink temperature readings were taken at different reverse current levels ranging from zero to 2.0 Amps. Reverse or back feed current was controlled by gradually reducing the external resistance thus directing more current produced by the micro-inverter into the AC Power Source amplifiers. In this current sinking (negative power factor) mode of operation, the power delivered by the micro-inverter must be also be dissipated in the linear amplifier's heat sinks.

As the reverse current essentially doubles the amount of power the heat sink must dissipate, the temperature runs higher than that experienced with equivalent current in source mode of operation. To reach around 500W of reverse power (2A at 240V) for the full load test, a second 250W micro-inverter was added.

The recorded temperatures in current sink mode are much higher than at equivalent current levels in source mode of operation. Data for phase A and B amplifier heat sinks is shown in Table 3 and Figure 8 below.

VAC (Vrms)	Load Current (A)	Power (W)	Heat Sink Temp (% of Shutdown Temp)	
			Phase A	Phase B
240	0.935	224.40	62.2%	66.2%
240	1.389	333.36	73.6%	78.0%
240	1.500	360.00	82.9%	83.1%
240	1.617	388.08	87.7%	86.8%
240	1.863	447.12	89.7%	88.1%

Table 3: Heat Sink Temperature as function of Load – Sink Mode

The heat sink temperature under current sink conditions rises quickly once the micro-inverter starts pushing 1.4A of RMS current into the AC Power Source. The temperature rise over time as a percent of the heat sink temperature trip point is shown in Figure 8. After 15 minutes, the heat sink temperatures reach thermal equilibrium and the AC Power Source demonstrates the ability to continuously operate at this level.

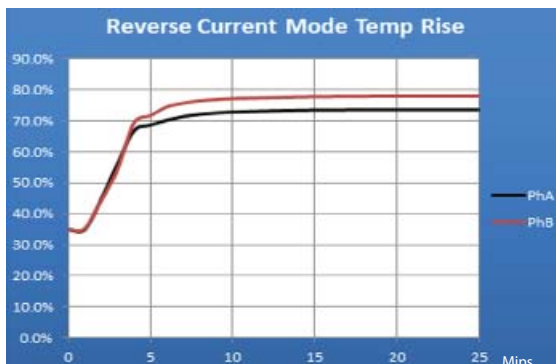

Figure 8: Reverse Current Mode Temperature Rise

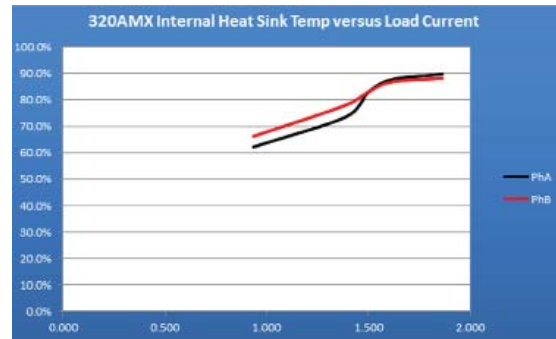

Figure 9: Temperature versus Current – Current Sink Operation

As indicated in Figure 9, once reverse power levels reach more than 450W, the AC Power Source's internal over temperature protection will eventually cause the power source to shut down. As this is a thermal limit, the time required will vary with both heat sink starting temperature and ambient temperature. Once the power source shuts down, the micro-inverters will shut down as they will lose AC grid synchronization.

Based on these test results, it is safe to conclude that the 320AMXT-UPC32 can operate continuously up to about 25% of its rated power in current sink mode. For larger PV inverter test and development applications, a larger sized AMX model can be applied or multiple AMX AC Power Sources can be paralleled as needed to provide sufficient levels of four quadrant operation. Furthermore, a suitable combination of external load and current sink capability will provide a more cost effective solution while still providing a seamless transition between source and sink mode of operation compared to using a PWM type AC Power Source that lacks four quadrant mode of operation.

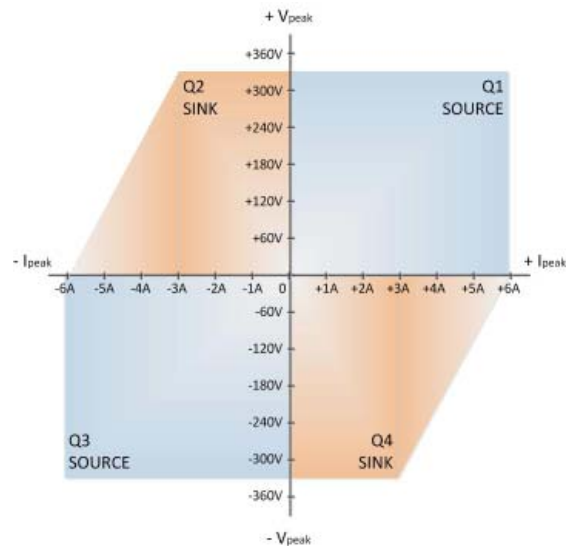

Figure 10: 320AMX 4 Quadrant Power Source Operating Curve

PV Inverter Testing

The use of an AC Power Source capable of four quadrant operation is ideally suited for PV inverter test applications. With full transient programming of frequency and voltage variations, design and development as well as compliance testing to regulatory standards is made much easier. The same AC Power Source can be deployed in production test applications to ensure product quality and energy efficiency.

Although both PWM mode switching AC Power Sources and linear mode AC Power Sources essentially serve the same purpose of voltage and frequency conversion, for bidirectional power flow applications such as the one described in this application note, the linear AC Power Source offers several unique advantages not offered by switch mode AC Power Source:

- The ability to both sink and source current and transition smoothly between both modes of operations: The linear AC Power Source is capable of sinking power by having reverse flow power dissipated in its internal heat sink. A switch mode AC source has no means to dispose of this energy as it causes its internal DC bus voltage to rise through the IGBT or FET body diodes of the output bridge which act as rectifiers. This results in dangerously high DC bus voltage levels which result in damage to the AC source internal hardware unless it shuts down to protect itself.
- Absence of any high frequency switching noise on its output: A linear AC Power Source eliminates the potential to negatively impact the constant power tracking algorithm of the PV inverter which can skew testing and development.

Other Benefits of Linear AC Power Sources

Additional advantages offered by linear AC Power Sources are:

- Low output impedance allowing for higher peak current generation
- High bandwidth resulting in faster voltage and load transient response
- Lower voltage distortion due to lack of zero cross over distortion typically encountered in PWM switch mode AC Power Sources.

Being one of the last remaining AC Power Source manufacturers that offers a complete line of switching or linear AC Power Sources, Pacific Power Source, Inc. is able to match the best available technology to the application at hand without any commercial bias.

Conclusion

Unique characteristics of linear AC Power Sources are often overlooked as the majority of AC Power Sources being made today rely on more compact and energy efficient switch mode technology. However, many applications benefit from the inherent advantages as outlined here in case of a PV inverter test application. With linear AC Power Source power levels ranging from 500VA to 90KVA, Pacific Power Source, Inc. is able to match the right AC Power Source to your application needs.



17692 Fitch, Irvine, CA 92614 USA

Phone: +1 949.251.1800

Fax: +1 949.756.0756

Toll Free: 800.854.2433

E-mail: sales@pacificpower.com

www.pacificpower.com